

CRANBORNE STONE

Walls, Piers and Finials Catalogue

Butts Pond, Sturminster Newton, Dorset DT10 1AZ
Telephone 01258 472685 *Fax* 01258 471251
email info@cranbornestone.com *web* www.cranbornestone.com

Catalogue version 0.16

Introduction

About Cranborne Stone

At Cranborne Stone we have been supporting property professionals with their building projects for over 30 years, utilising our extensive knowledge and skill in supply of cast stone architectural features.

Our team is made up of approachable estimators, creative designers, skilled craftsmen and a diligent delivery team as well as the essential back office support that ensures each project runs smoothly.

We are proud of our reputation for being easy to deal with and for having a flexible approach enabling us to match the individual demands of each project and look forward to demonstrating these to you.



Guides are available for each of our products. These will help you choose the correct components and assist you in installation.

Our range of standard colours have been developed to reflect the regional variations of true stone.



Bath Yellow



Cotswold

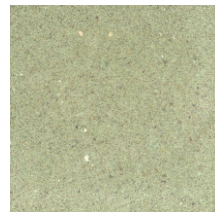

Shaftesbury Green



York



Portland White



Italian Terracotta

Developing a Property with Cranborne Stone

High quality cast stone features will enhance any property project from the restoration of a historic building to a contemporary style new build.

With Cranborne Stone property developers not only benefit from supply of a wide range of distinctive architectural features but also clear and responsive project support.

- **Wide range of styles & features**
- **Bespoke design service**
- **Choice of regional stone colours**
- **Colour matching service to blend the new with existing**
- **Named support for each project**
- **Interpretation of initial drawings**
- **Sound advice on managing cost whilst maintaining aesthetic consistency**
- **Provision of detailed drawings**
- **Restoration capability**
- **Fitting service**
- **Clear to read quotations**
- **Agreed delivery dates**

If you would like to know more or would like specific assistance with a project please call or email one of our knowledgeable team who will be pleased to help.

Contents

Balls and Bases

9" Balls and Bases	1.1
12" Balls and Bases	1.2
14" Balls and Bases	1.3
17" Balls and Bases	1.4

Pier Caps

Plain	2.1
Part Weathered	2.2
Flat Decorated	2.3
Weathered Plain	2.4
Weathered Decorated	2.5
Combination Ideas 440mm Piers	2.6
Combination Ideas 552mm Piers	2.7
Combination Ideas 665mm Piers	2.8

Gate Piers

GP120, GP10, and GP20 Gate Piers	3.1
GP70A Gate Pier	3.2
GP90 Gate Pier	3.3
GP60 and GP110 Gate Piers	3.4

Coping

Plain Coping	4.1
Part Weathered	4.2
Once Weathered	4.3
Once Weathered Decorated	4.4
Twice Weathered	4.5
Flat Decorated	4.6
Weathered Decorated	4.7

Information

CAD and technical information	5.1
Glossary and FAQ's	5.2

9" Balls and Bases

Our smallest ball finial adds a classical detail to finish the finest of piers.

Code	F090 9" Ball and bases		Height		Weight	
	Height (mm)	Width (mm)	inc. ball* (mm)	Weight (Kg)	inc. ball (Kg)	
F090	224	229	n/a	12	n/a	
UP06P	122	303	352	20	32	
F092	152	178	382	4	16	
UP11	165	330	395	32	44	
F121	254	229	484	16	28	
F093	279	356	509	28	40	
F171	330	356	560	32	44	

*Height including ball includes one 6mm joint

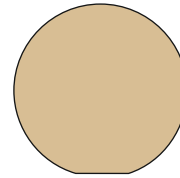

9" ball only F090

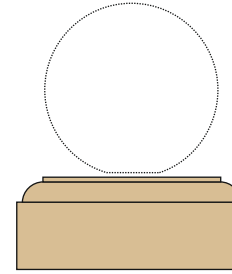

Plinth UP06P

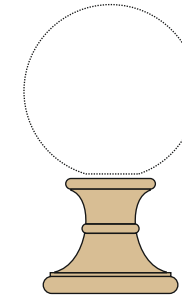

Round base F092

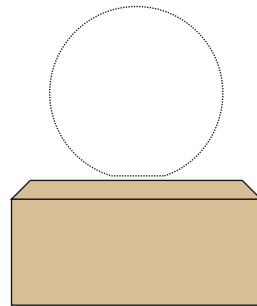

Chamfered block UP11

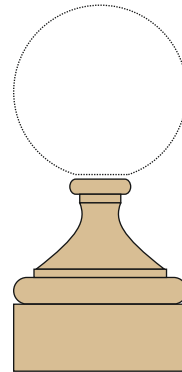

Square base 9" F121

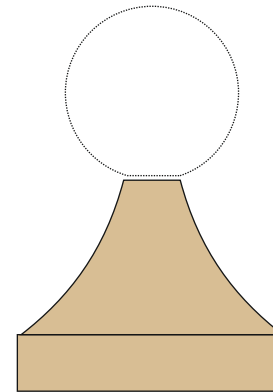

Sloping base F093

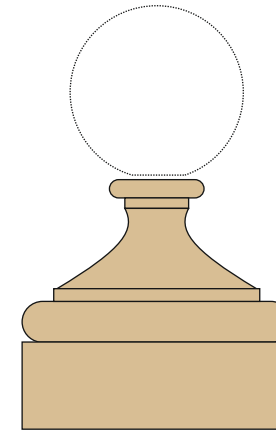

Square base 14" F171

12" Balls and Bases

Suitable for piers of a variety of sizes, our 12" ball is perfectly formed with a range of bases.

F120 12" Ball and bases		Height		Weight	
Code	Height (mm)	Width (mm)	inc. ball* (mm)	Weight (Kg)	inc. ball (Kg)
F120	301	305	n/a	30	n/a
UP06P	122	303	429	20	50
F092	152	178	459	4	34
UP11	165	330	472	32	62
F121	254	229	561	16	46
F093	279	356	586	28	58
F171	330	356	637	32	62

*Height including ball includes one 6mm joint

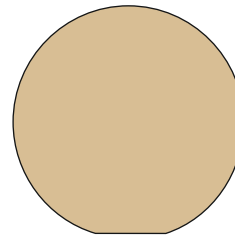

12" ball only F120

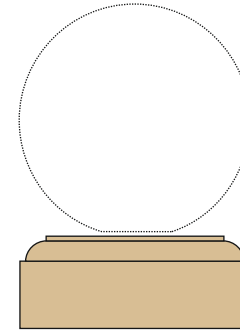

Plinth UP06P

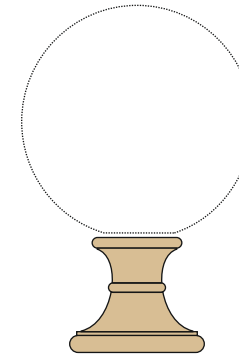

Round base F092

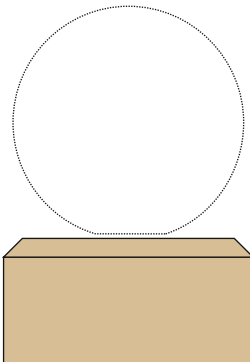

Chamfered block UP11

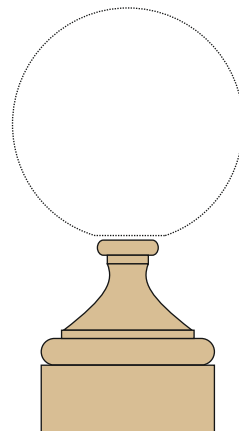

Square base 9" F121

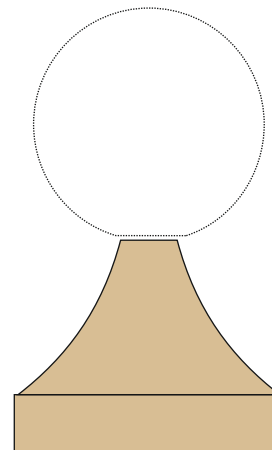

Sloping base F093

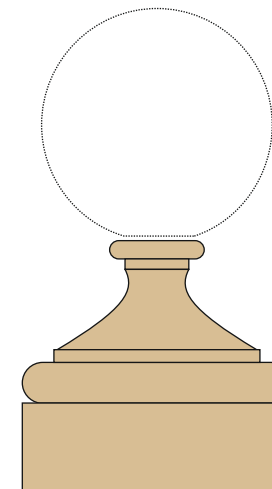

Square base 14" F171

14" Balls and Bases

Slightly larger than our 12" ball, the 14" ball adds an increased dominance to grand entrances and larger gateways.

Code	F140 14" Ball and bases		Height		Weight	
	Height (mm)	Width (mm)	inc. ball*	inc. ball	(Kg)	(Kg)
F140	350	355	n/a	45	n/a	
UP06P	122	303	478	20	65	
F092	152	178	508	4	49	
UP11	165	330	521	32	77	
F121	254	229	610	16	61	
F093	279	356	635	28	73	
F171	330	356	686	32	77	

*Height including ball includes one 6mm joint

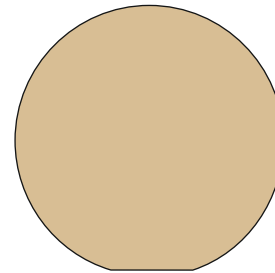

14" ball only F140

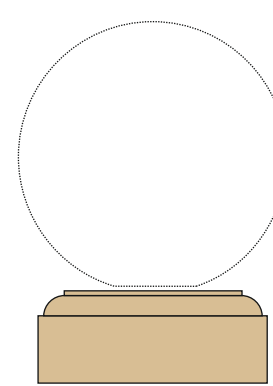

Plinth UP06P

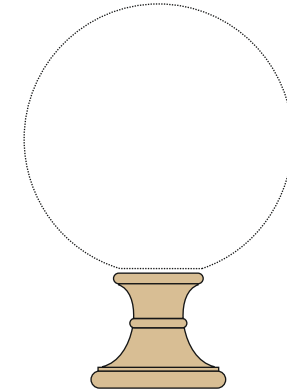

Round base F092

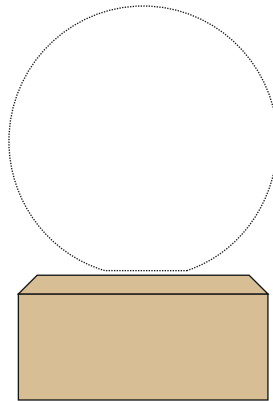

Chamfered block UP11

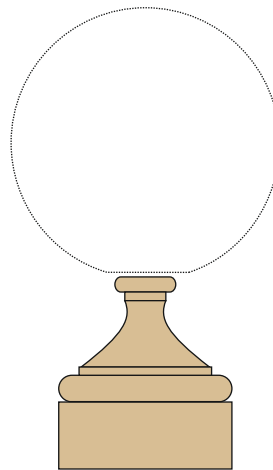

Square base 9" F121

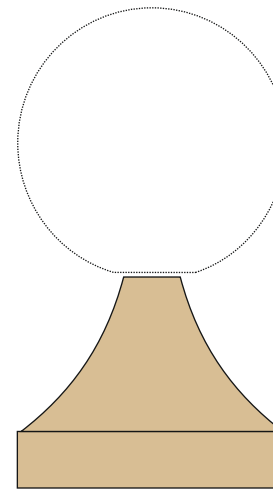

Sloping base F093

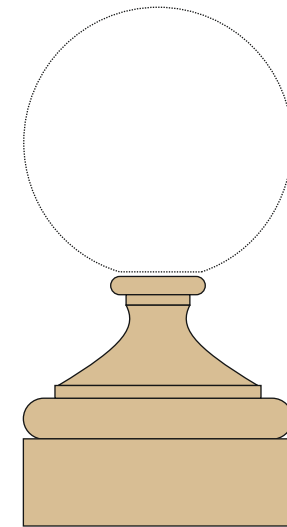

Square base 14" F171

17" balls and Bases

Our largest ball and our ornate pineapple finial perfectly compliment the grandest of entrances.

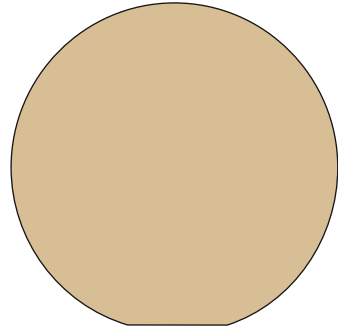

17" ball only F170

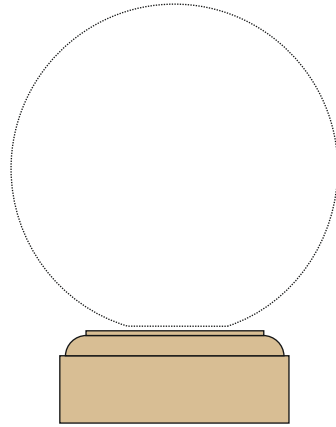

Plinth UP06P

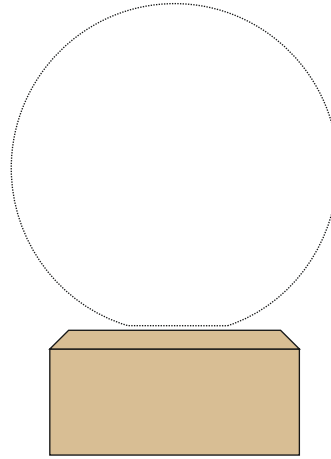

Chamfered block UP11

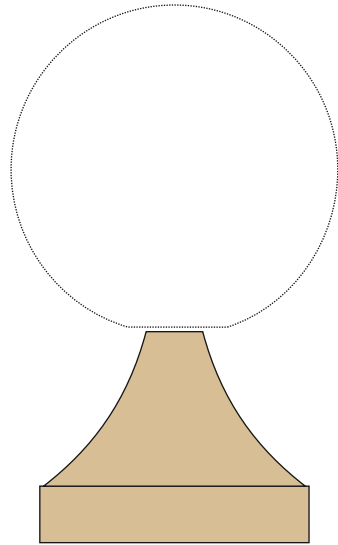

Sloping base F093

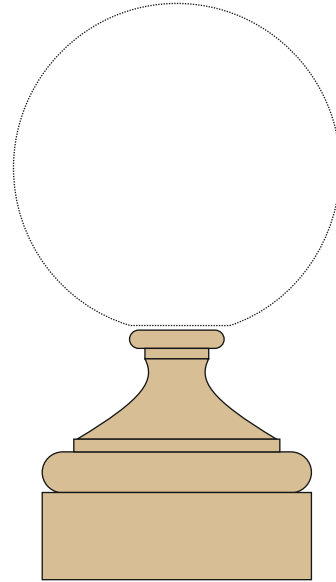

Square base 14" F171

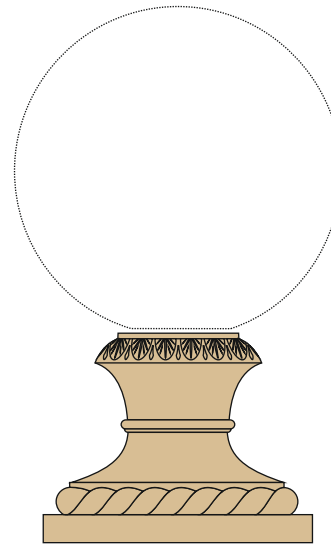

F002B Rope Base

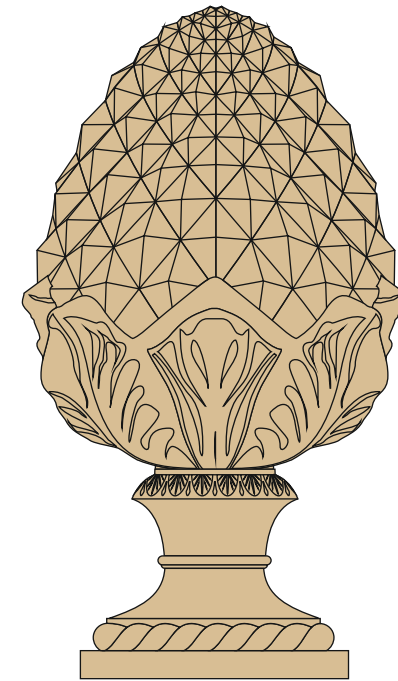

Pineapple and Base F002
Overall height 889mm
Base width 330mm
Maximum width 508mm
Total weight 104kg

Code	F170 17" Ball and bases			Height	
	Height (mm)	Width (mm)	inc. ball* (mm)	Weight (Kg)	inc. ball (Kg)
F170	426	432	n/a	80	n/a
UP06P	122	303	554	20	100
UP11	165	330	597	32	112
F093	279	356	711	28	108
F171	330	356	762	32	112
F002B	277	330	709	24	104

*Height including ball includes one 6mm joint

Pier Caps - Plain

Plain Pier Caps can finish a simple pier or provide a perfect base for a wide choice of finials.

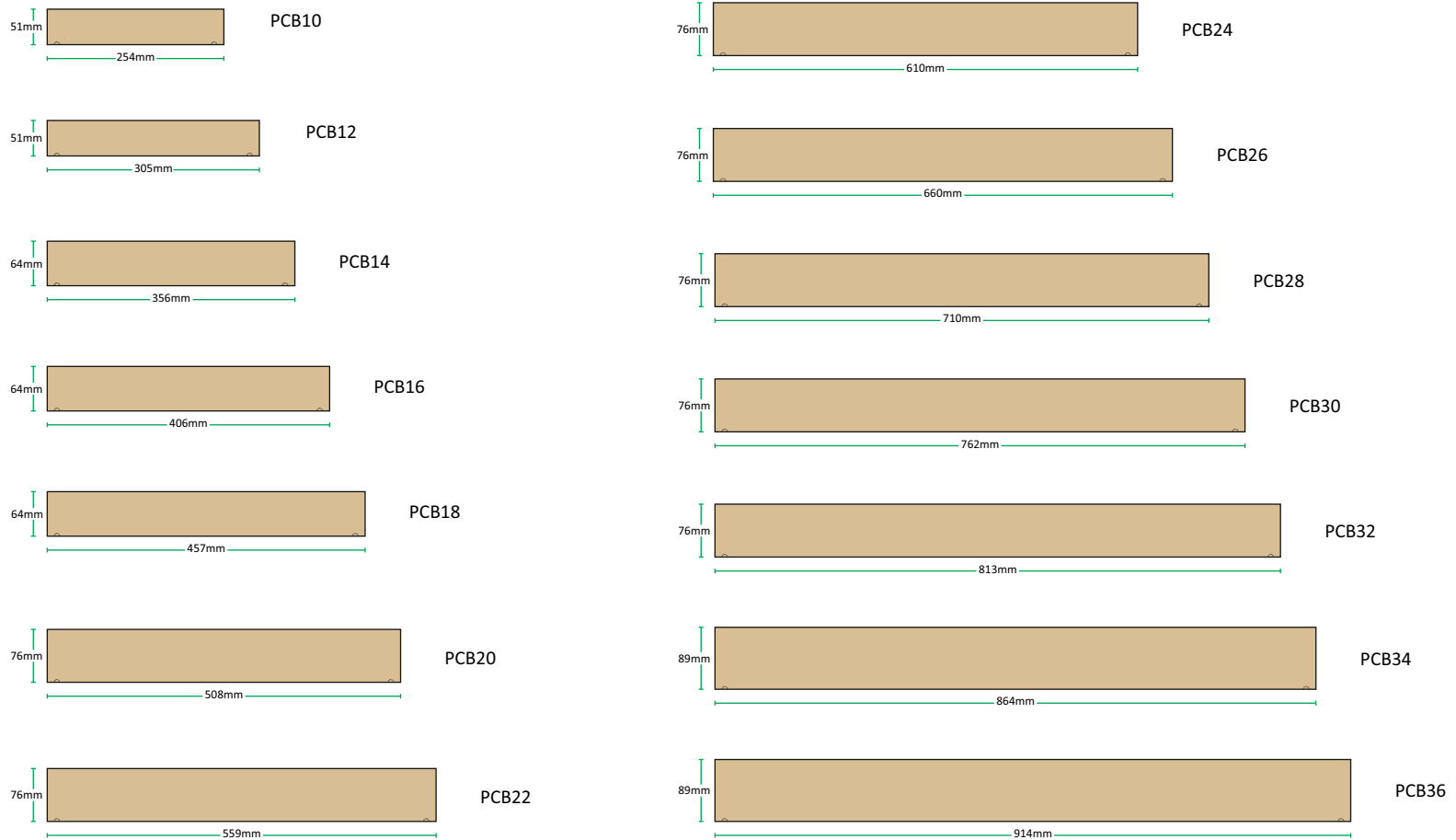

Code	Height (mm)	Width (mm)	Length (mm)	Max.* Pier width (mm)	Weight (Kg)
PCB10	51	254	254	204	7
PCB12	51	305	305	255	10
PCB14	64	356	356	306	17
PCB16	64	406	406	356	22
PCB18	64	457	457	407	28
PCB20	76	508	508	458	41
PCB22	76	559	559	509	50

Code	Height (mm)	Width (mm)	Length (mm)	Max.* Pier width (mm)	Weight (Kg)
PCB24	76	610	610	560	56
PCB26	76	660	660	610	70
PCB28	76	710	710	660	76
PCB30	76	762	762	712	93
PCB32	76	813	813	763	105
PCB34	89	864	864	814	140
PCB36	89	914	914	864	156

*Maximum wall width allows 25mm either side for drip and overhang.

Pier Caps - Part Weathered

Part Weathered Pier Caps can add a subtle detail to your piers, perfectly complimenting our part weathered coping.

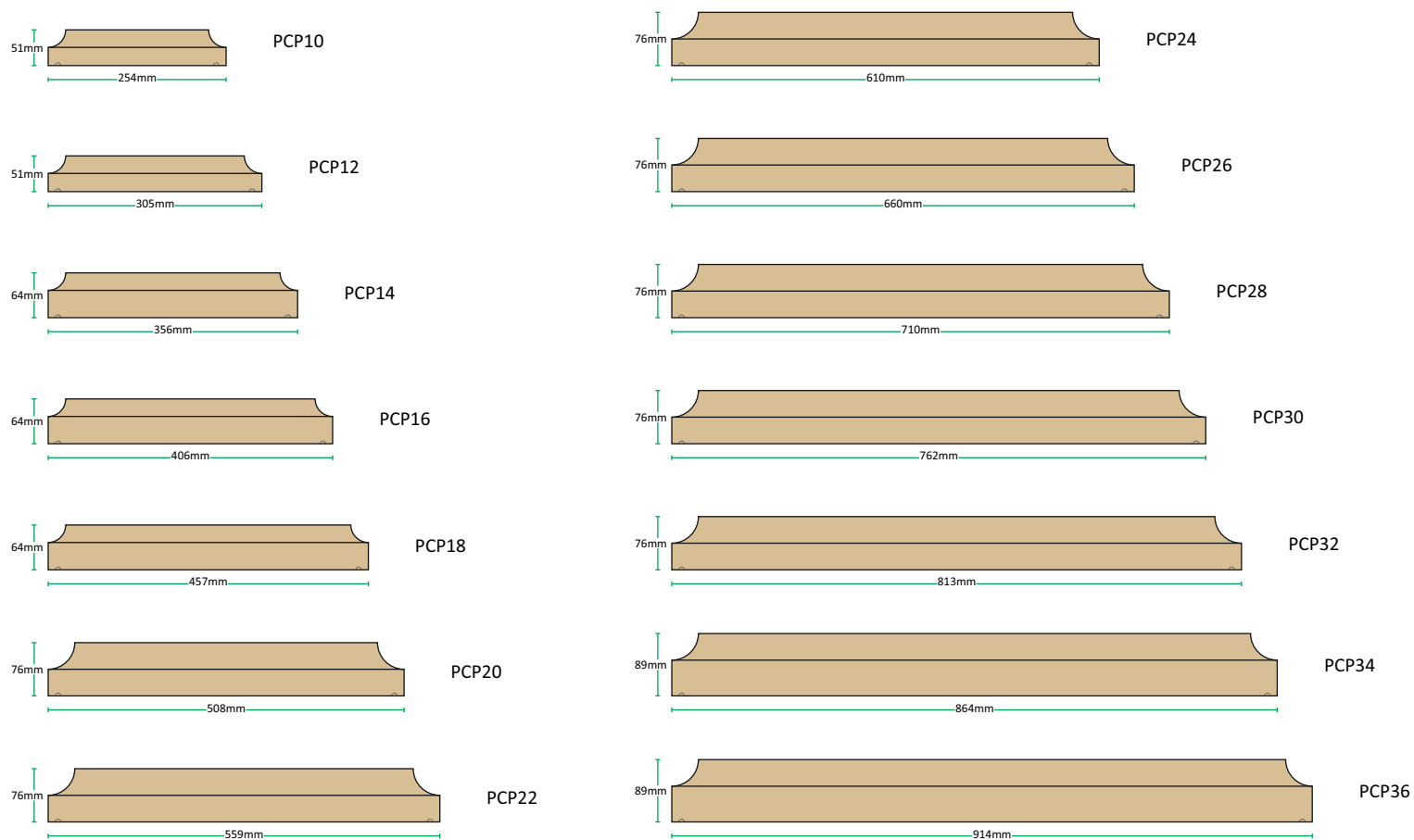

Code	Height (mm)	Width (mm)	Length (mm)	Max.* Pier width (mm)	Weight (Kg)
PCP10	51	254	254	204	6
PCP12	51	305	305	255	9
PCP14	64	356	356	306	16
PCP16	64	406	406	356	20
PCP18	64	457	457	407	26
PCP20	76	508	508	458	36
PCP22	76	559	559	509	45

Code	Height (mm)	Width (mm)	Length (mm)	Max.* Pier width (mm)	Weight (Kg)
PCP24	76	610	610	560	54
PCP26	76	660	660	610	63
PCP28	76	710	710	660	74
PCP30	76	762	762	712	85
PCP32	76	813	813	763	98
PCP34	89	864	864	814	131
PCP36	89	914	914	864	147

*Maximum wall width allows 25mm either side for drip and overhang.

Pier Caps - Flat Decorated

Along with adding a decorative detail, these Pier Caps can be used to finish a pier or provide a perfect base for your finial.

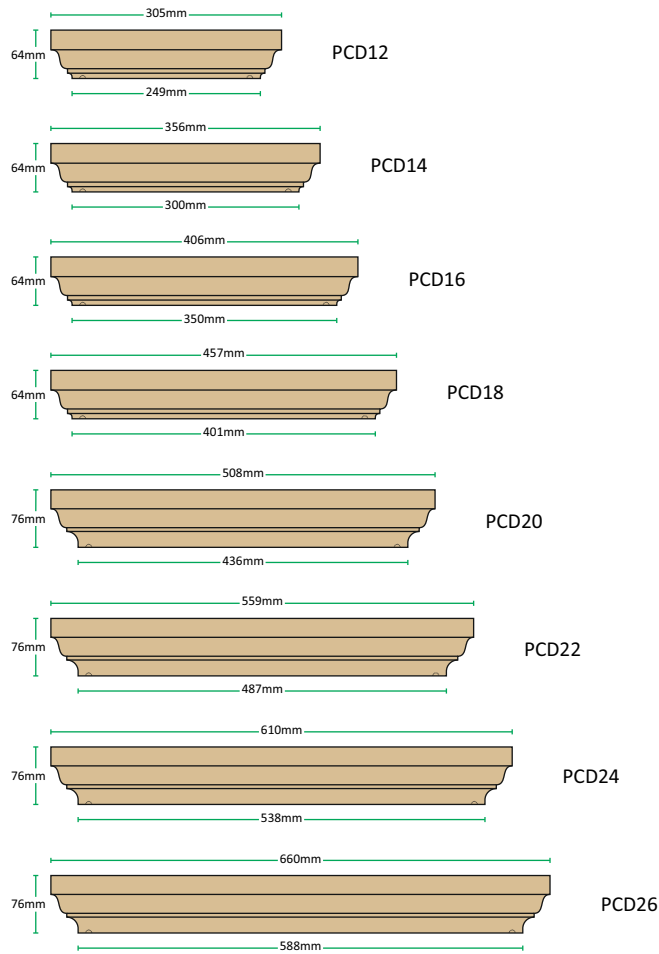

Code	Height (mm)	Width (mm)	Length (mm)	Pier width (mm)	Max.* Weight (Kg)
PCD12	64	305	305	199	11
PCD14	64	356	356	250	15
PCD16	64	406	406	300	20
PCD18	64	457	457	351	26
PCD20	76	508	508	386	37
PCD22	76	559	559	437	45
PCD24	76	610	610	488	54
PCD26	76	660	660	538	64

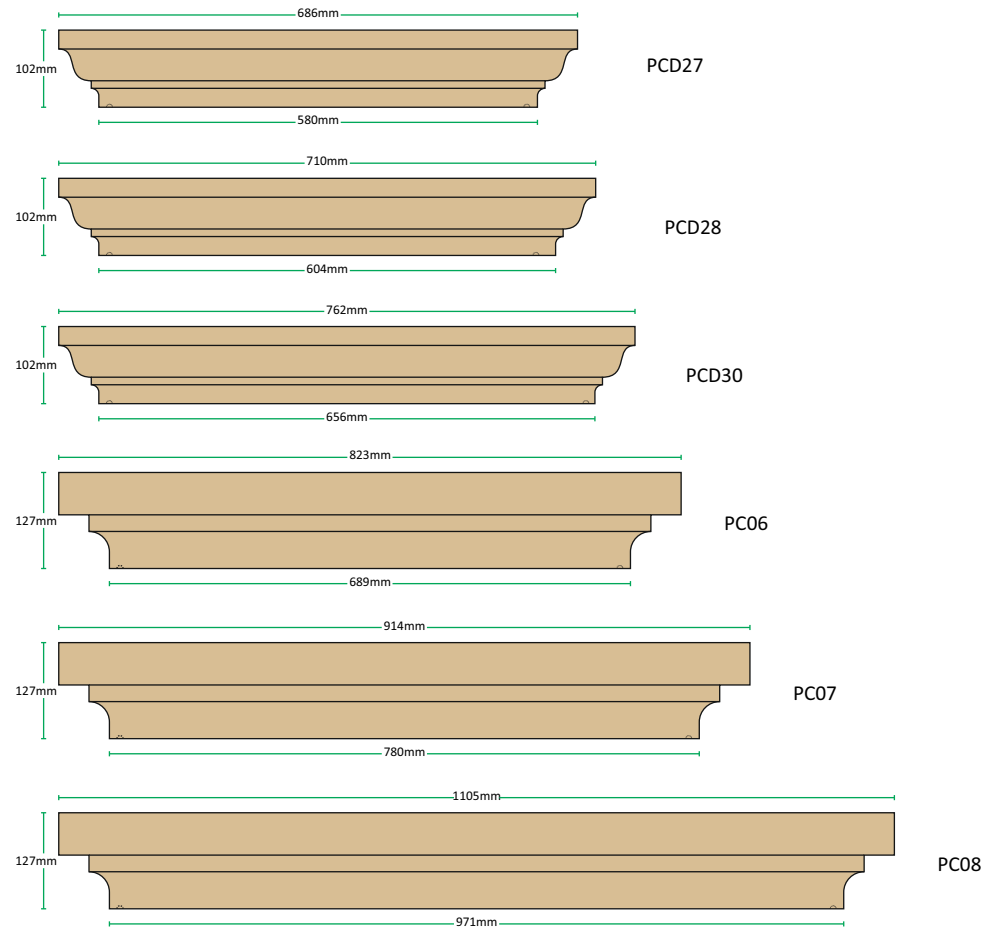

Code	Height (mm)	Width (mm)	Length (mm)	Pier width (mm)	Max.* Weight (Kg)
PCD26	76	660	660	583	64
PCD27	102	686	686	530	86
PCD28	102	710	710	554	93
PCD30	102	762	762	606	108
PC06	127	823	823	639	153
PC07	127	914	914	780	192
PC08	127	1105	1105	921	289

*Maximum wall width allows 25mm either side for drip and overhang.

Pier Cap - Weathered Plain

Weathered Pier Caps combine practicality and form to provide maximum protection for your piers.

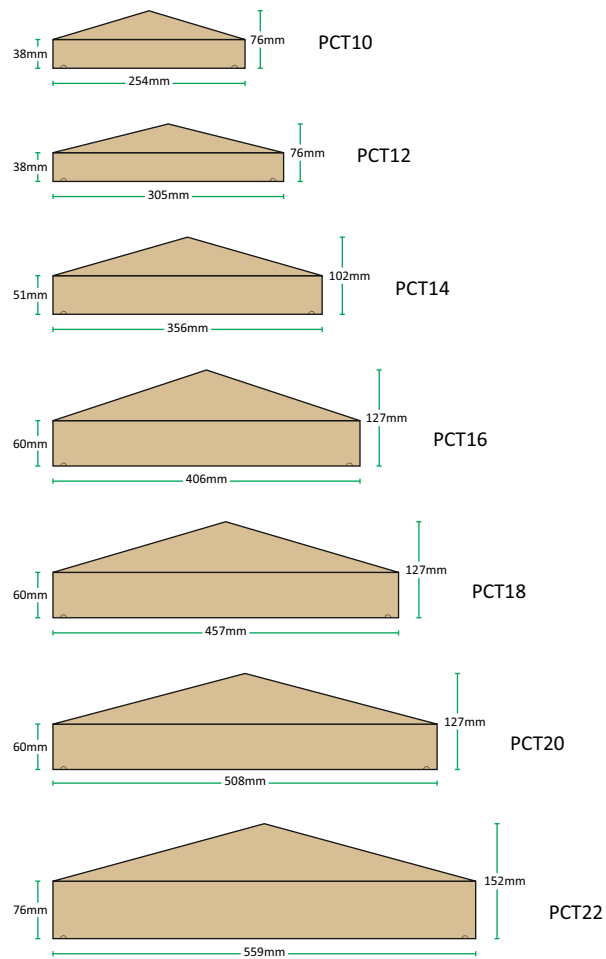

Code	Height (mm)	Width (mm)	Length (mm)	Pier width (mm)	Weight (Kg)
PCT10	38	254	254	204	7
PCT12	38	305	305	255	10
PCT14	51	356	356	306	18
PCT16	60	406	406	356	29
PCT18	60	457	457	407	36
PCT20	60	508	508	458	45
PCT22	76	559	559	509	66

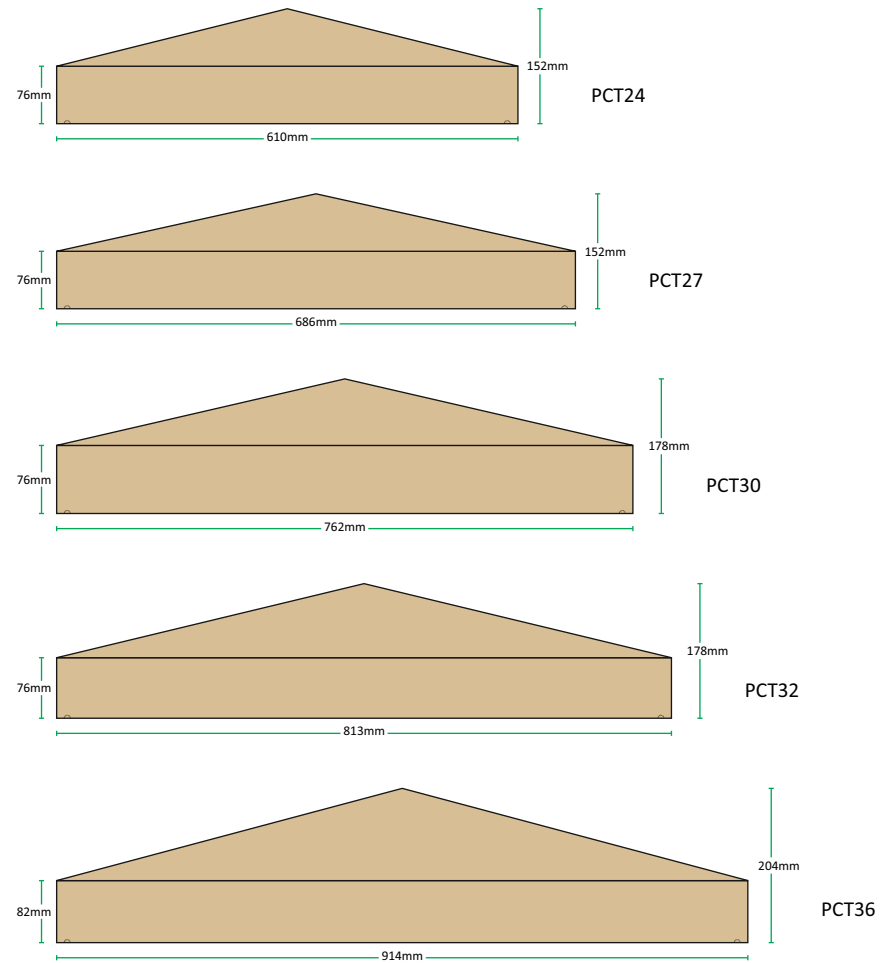

Code	Height (mm)	Width (mm)	Length (mm)	Pier width (mm)	Weight (Kg)
PCT24	76	610	610	560	79
PCT27	76	686	686	636	100
PCT30	76	762	762	712	134
PCT32	76	813	813	763	153
PCT36	82	914	914	864	215

*Maximum wall width allows 25mm either side for drip and overhang.

Pier Caps - Weathered Decorated

Weathered Decorated Pier Caps offer the performance of weathering combined with a classical detail embellishing your pier.

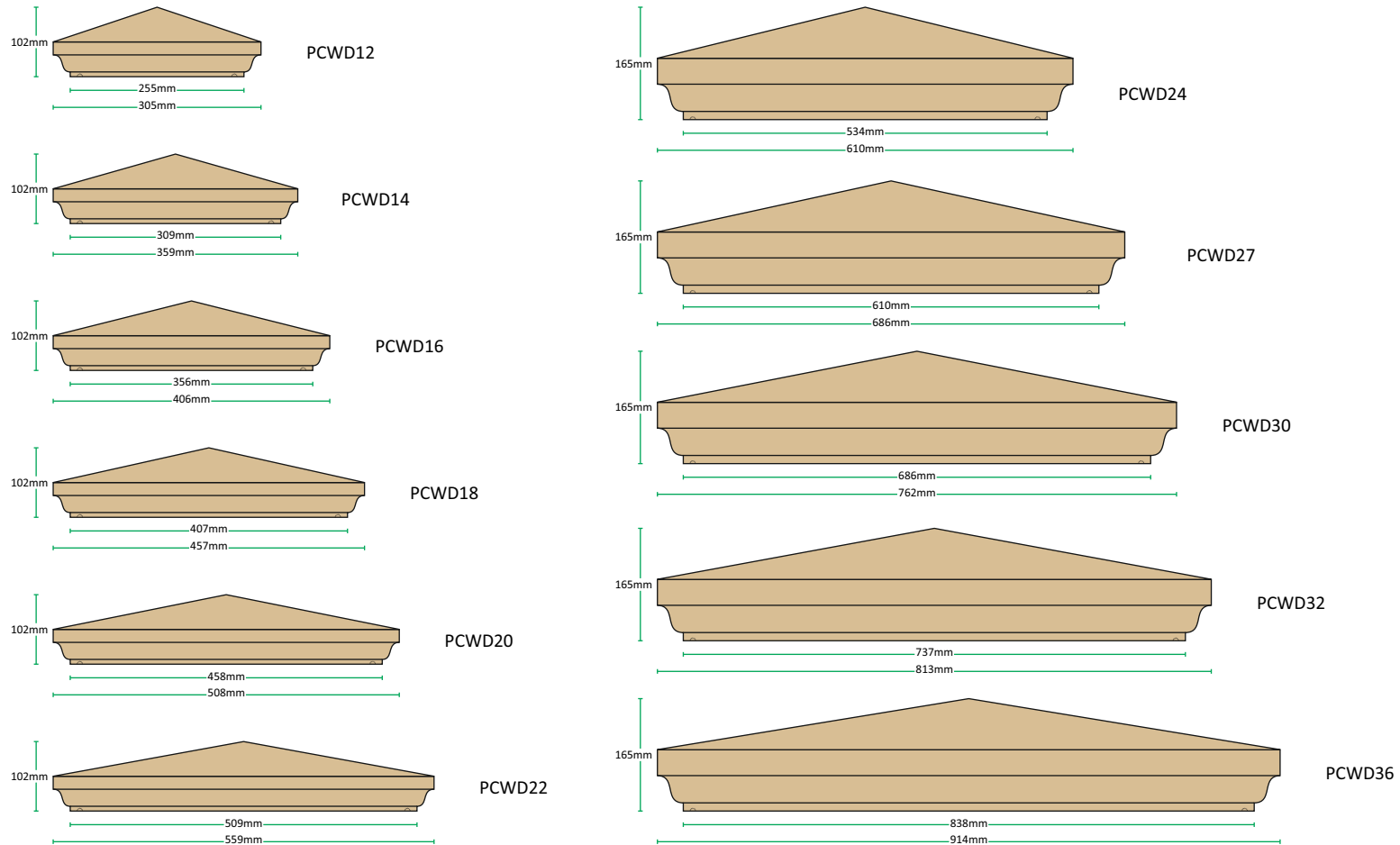

Code	Height (mm)	Width (mm)	Length (mm)	Max.* Pier width (mm)	Weight (Kg)
PCWD12	102	305	305	205	12
PCWD14	102	359	359	259	17
PCWD16	102	406	406	306	22
PCWD18	102	457	457	357	28
PCWD20	102	508	508	408	35
PCWD22	102	559	559	459	43

Code	Height (mm)	Width (mm)	Length (mm)	Max.* Pier width (mm)	Weight (Kg)
PCWD24	165	610	610	484	85
PCWD27	165	686	686	560	108
PCWD30	165	762	762	636	134
PCWD32	165	813	813	687	153
PCWD36	165	914	914	788	194

*Maximum wall width allows 25mm either side for drip and overhang.

Pier Cap Combinations

Example Pier Cap combinations to suit 440mm wide Piers

A large proportion of our Pier Caps can be combined to create an impressive and ornate feature for your Piers.
If you require any suggestions, please contact our technical team with the sizes that you require, we will be happy to suggest some suitable combinations.

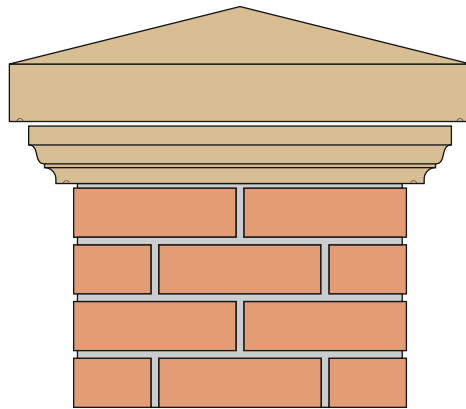

Combination A
Overall Height¹ of 234mm
Overall Width of 610mm
Consists of:
PCT24 Weathered Pier Cap
PCD22 Flat Decorated Pier Cap
Total weight 124 kgs

¹ Includes 1no. 6mm joints

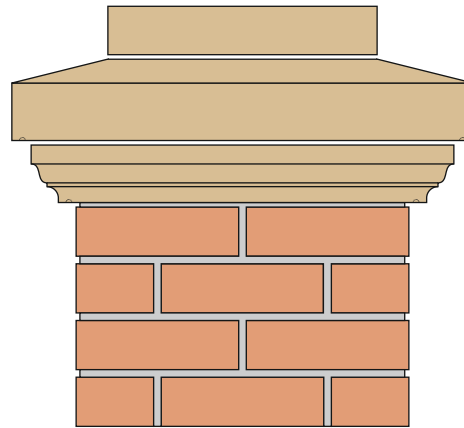

Combination B
Overall Height¹ of 254mm
Overall Width of 610mm
Consists of:
PCB14 Plain Pier Cap
PCH24 Half Weathered Pier Cap
PCD22 Flat Decorated Pier Cap
Total weight 130 kgs

¹ Includes 2no. 6mm joints

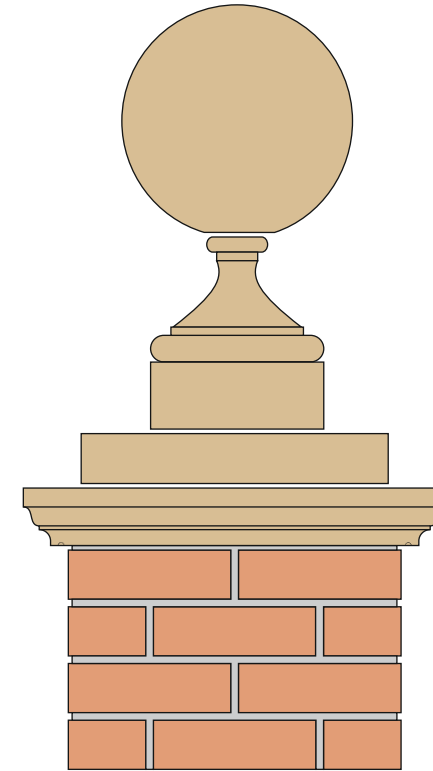

Combination C
Overall Height¹ of 713mm
Overall Width of 559mm
Consists of:
F120 12" Ball
F121 Square Base
PCB16 Plain Pier Cap
PCD22 Flat Decorated Pier Cap
Total weight 113 kgs

¹ Includes 3no. 6mm joints

Pier Cap Combinations

Example Pier Cap Combinations to suit 552mm wide piers.

A large proportion of our Pier Caps can be combined to create an impressive and ornate feature for your Piers.
If you require any suggestions, please contact our technical team with the sizes that you require, we will be happy to suggest some suitable combinations.

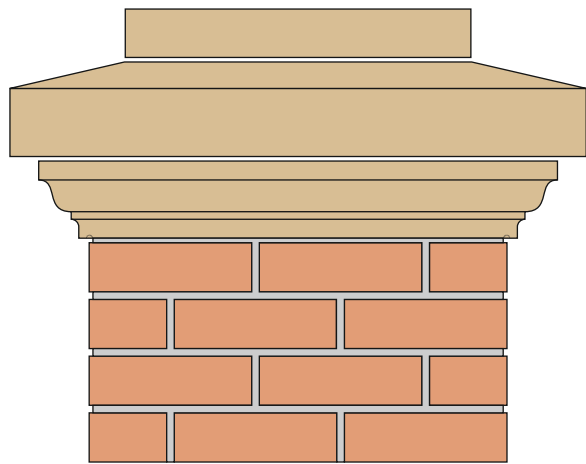

Combination D
Overall Height¹ of 303mm
Overall Width of 762mm
Consists of:
PCB18 Plain Pier Cap
PCH30 Half Weathered Pier Cap
PCD27 Flat Decorated Pier Cap
Total weight 220 kgs

¹ Includes 2no. 6mm joints

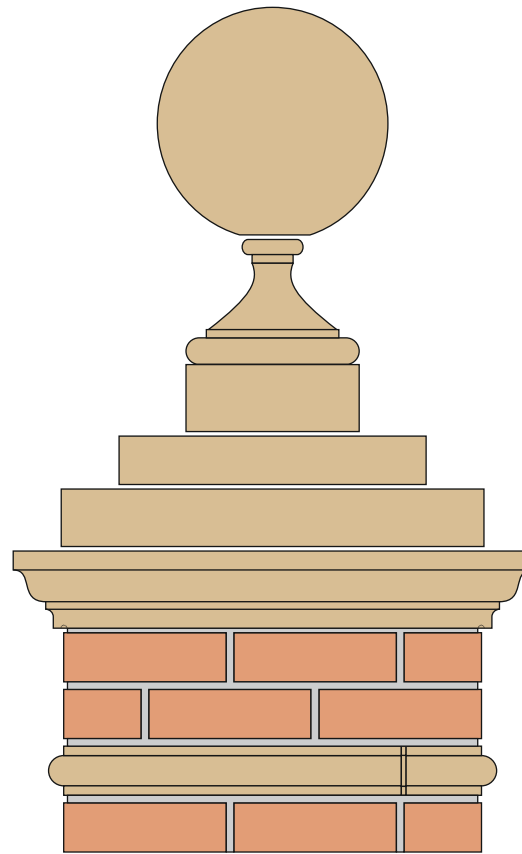

Combination E
Overall Height¹ of 821mm
Overall Width of 686mm
Consists of:
F120 12" Ball
F121 Square Base
PCB16 Plain Pier Cap
PCB18 Plain Pier Cap
PCD27 Flat Decorated Pier Cap
SC10/552 String Course
Total weight 226 kgs

¹ Includes 4no. 6mm joints

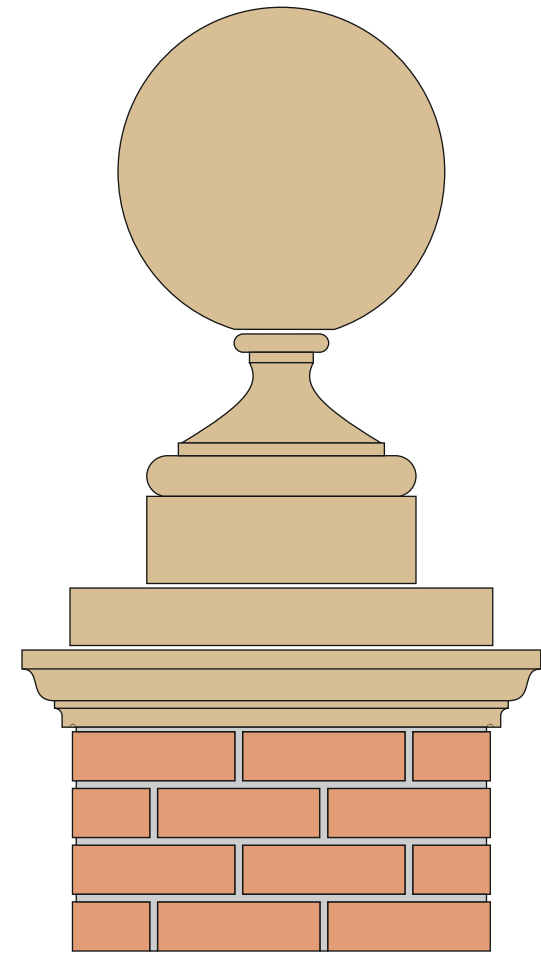

Combination F
Overall Height¹ of 958mm
Overall Width of 686mm
Consists of:
F170 17" Ball
F171 Square Base
PCB18 Plain Pier Cap
PCD27 Flat Decorated Pier Cap
Total weight 248 kgs

¹ Includes 3no. 6mm joints

Pier Cap Combinations

Example Pier Cap Combinations to suit 665mm wide piers.

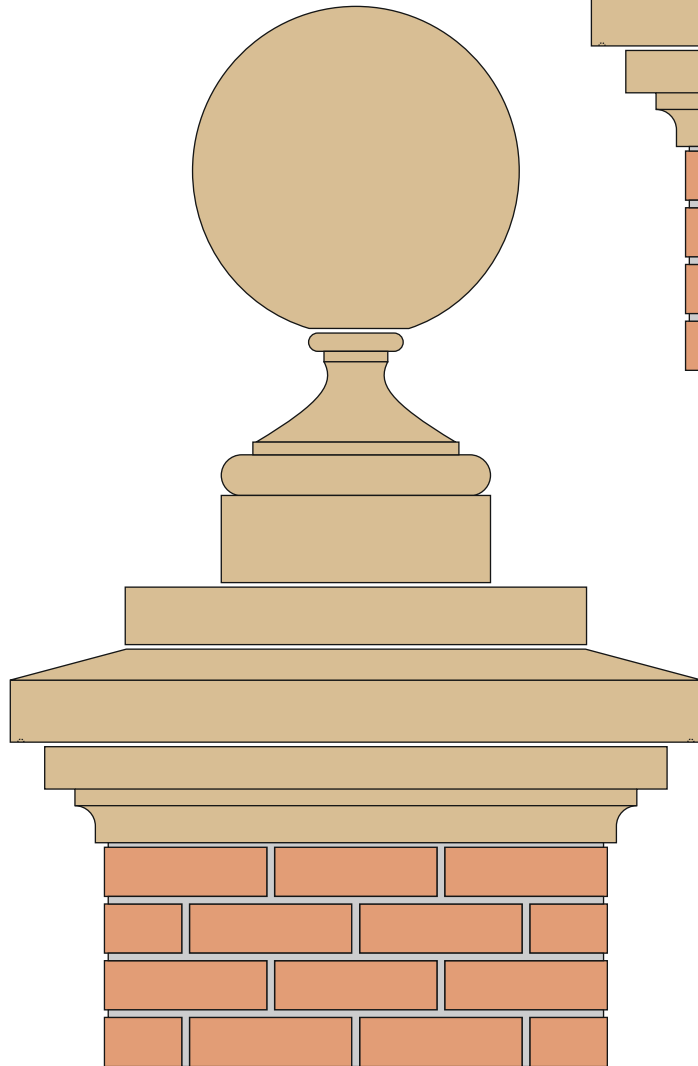

Combination G (Left)
 Overall Height¹ of 1106mm
 Overall Width of 914mm
 Consists of:
 F170 17" Ball
 F171 Square Base
 PCB24 Plain Pier Cap
 PCH36 Half Weathered Pier Cap
 PC06 Flat Decorated Pier Cap
 Total weight 473 kgs

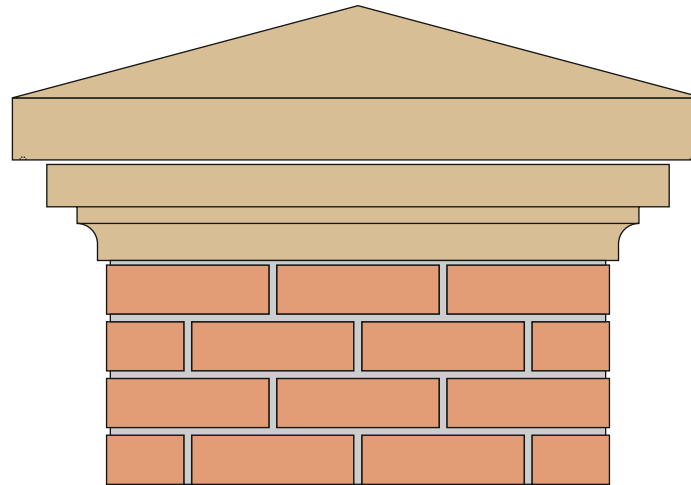

Combination H (Above)
 Overall Height² of 337mm
 Overall Width of 914mm
 Consists of:
 PCT36 Weathered Pier Cap
 PC06 Flat Decorated Pier Cap
 Total weight 368 kgs

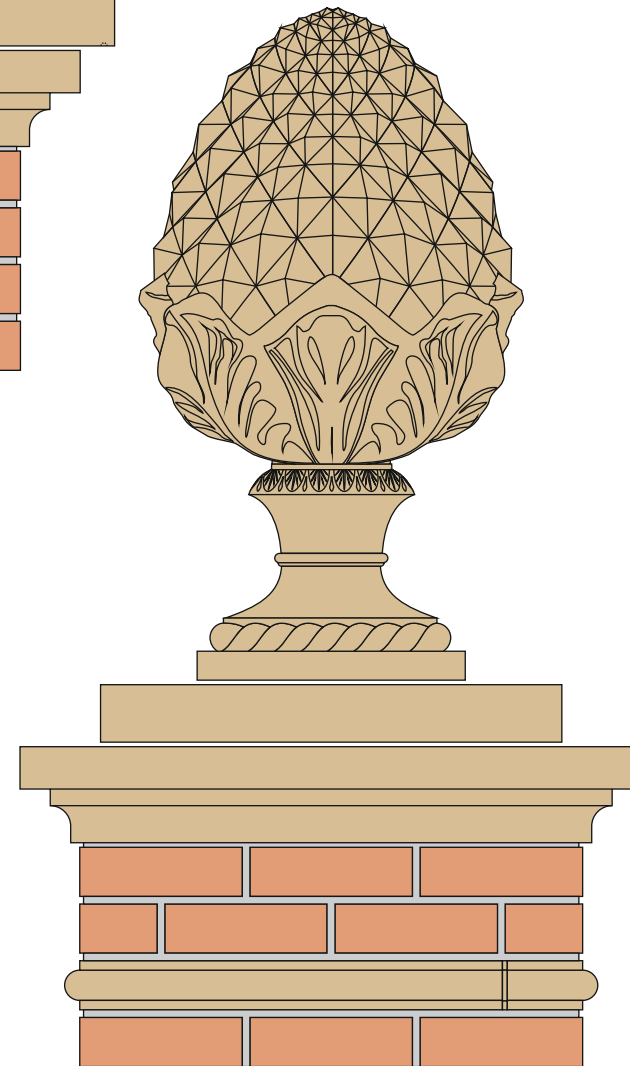

Combination I (Right)
 Overall Height³ of 1104mm
 Overall Width of 823mm
 Consists of:
 F002 Pineapple Finial and Base
 PC06 Flat Decorated Pier Cap
 SC10/665 String Course
 Total weight 340 kgs

¹ Includes 4no. 6mm joints ² Includes 1no. 6mm joints ³ Includes 2 no. 6mm joints

GP120, GP10, and GP20 Gate Piers

Our range of Gate Piers are designed to provide support for gates, or simply define and enhance any entrance.

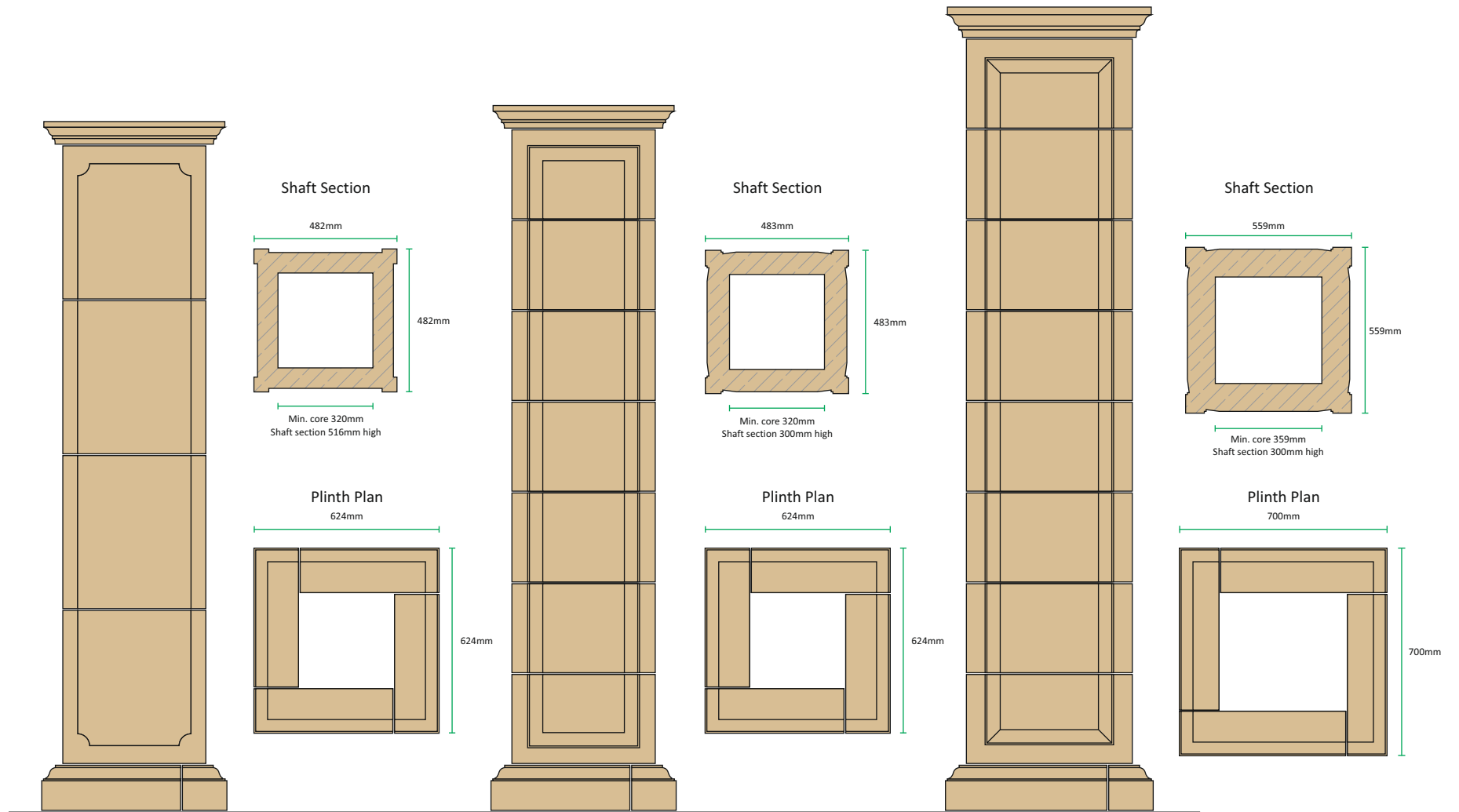

GP120
 Overall Height¹ of 2328mm
 Width of base 624mm
 Width of shaft 482mm
 Width of cap 610mm
 Internal core of 320mm square
 Total weight 593 kgs

¹ Overall height includes
 6no. 6mm mortar joints

GP10
 Overall Height² of 2382mm
 Width of base 624mm
 Width of shaft 483mm
 Width of cap 610mm
 Internal core of 320mm square
 Total weight 603 kgs

² Overall height includes
 9no. 6mm mortar joints

GP20
 Overall Height³ of 2714mm
 Width of base 700mm
 Width of shaft 559mm
 Width of cap 687mm
 Internal core of 359mm square
 Total weight 904 kgs

³ Overall height includes
 10no. 6mm mortar joints

All our columns are available in a range of height configurations, please contact a member of our technical team with your requirements on 01258 472685.

GP70A Gate Pier

Our GP70A Gate Piers are highly decorative, providing an embellished detail to any entrance.

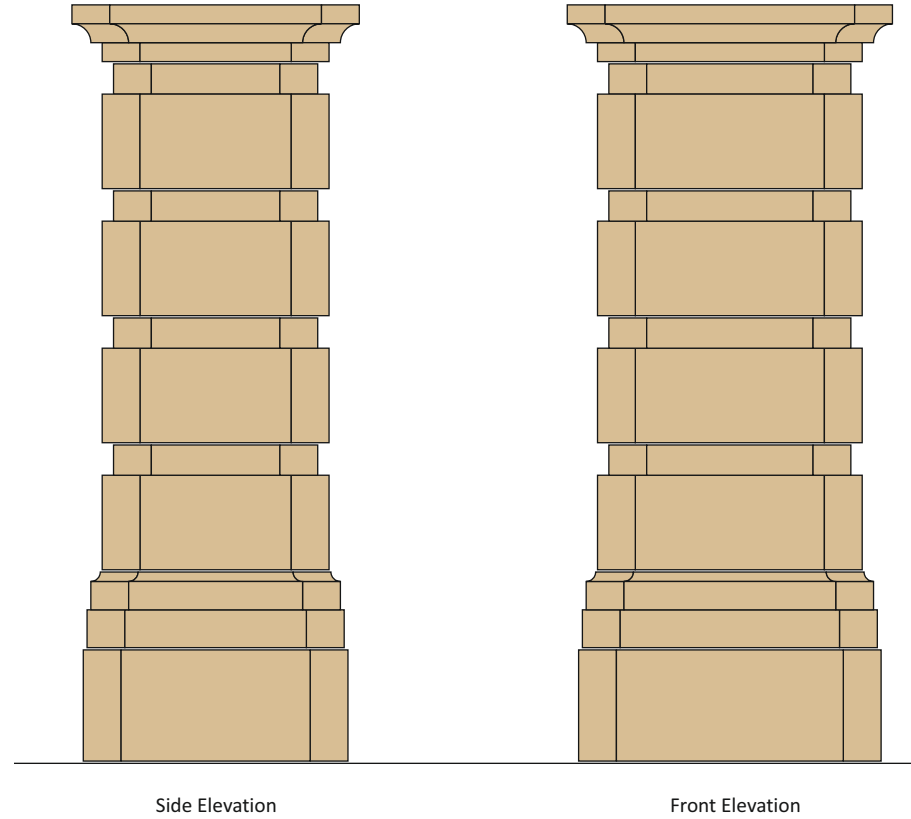
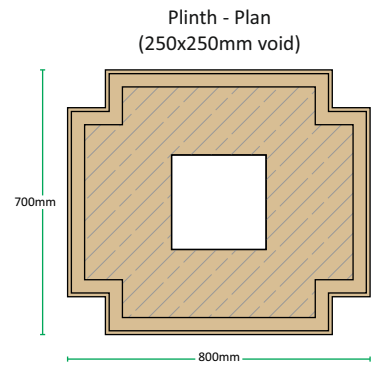
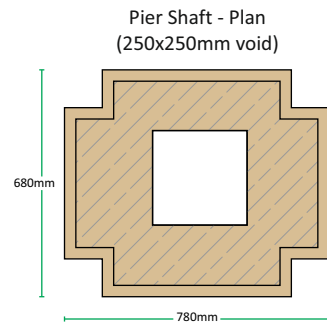
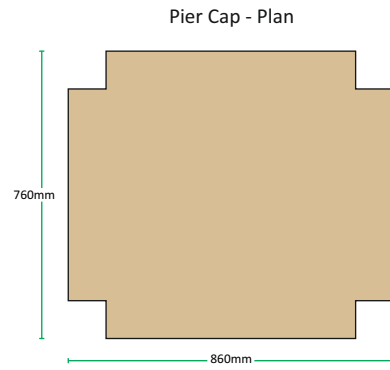

GP70A
 Overall Height¹ of 2000mm
 Dimensions of base 800x700mm
 Dimensions of shaft 700x600mm
 Dimensions of cap 860x760mm
 Internal core of 250mm square
 Shaft section height of 330mm
 Total weight 1340 kgs

¹ Overall height includes
 6no. 6mm mortar joints

All our columns are available in a range of height configurations, please contact a member of our technical team with your requirements on 01258 472685.

GP90 Gate Pier

The GP90 Gate Pier offers an individual design for your entrance, complimenting classic and contemporary design.

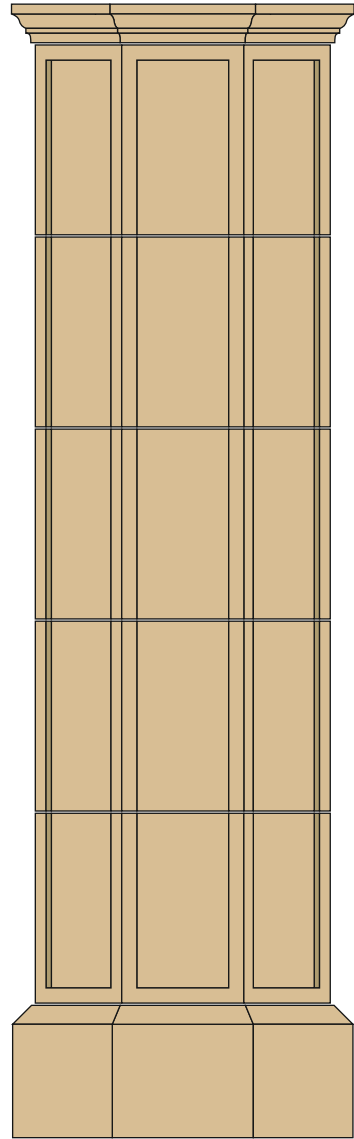

GP90
Overall Height¹ of 2998mm
Width of base 900mm
Width of shaft 780mm
Width of cap 906mm
Internal core of 550mm diameter
Shaft section height of 502mm
Total weight 1681 kgs

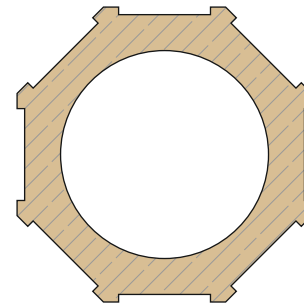

Section through Shaft

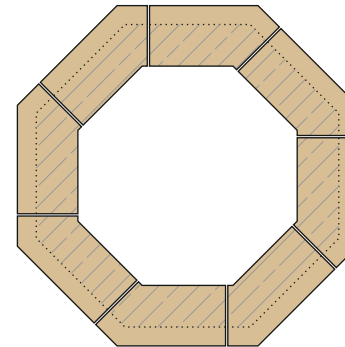

Section through Plinth

¹ Overall height includes
7no. 6mm mortar joints

All our columns are available in a range of height configurations, please contact a member of our technical team with your requirements on 01258 472685.

GP60 and GP110 Gate Piers

Our largest classical gate piers also offer great flexibility, with many height options available.

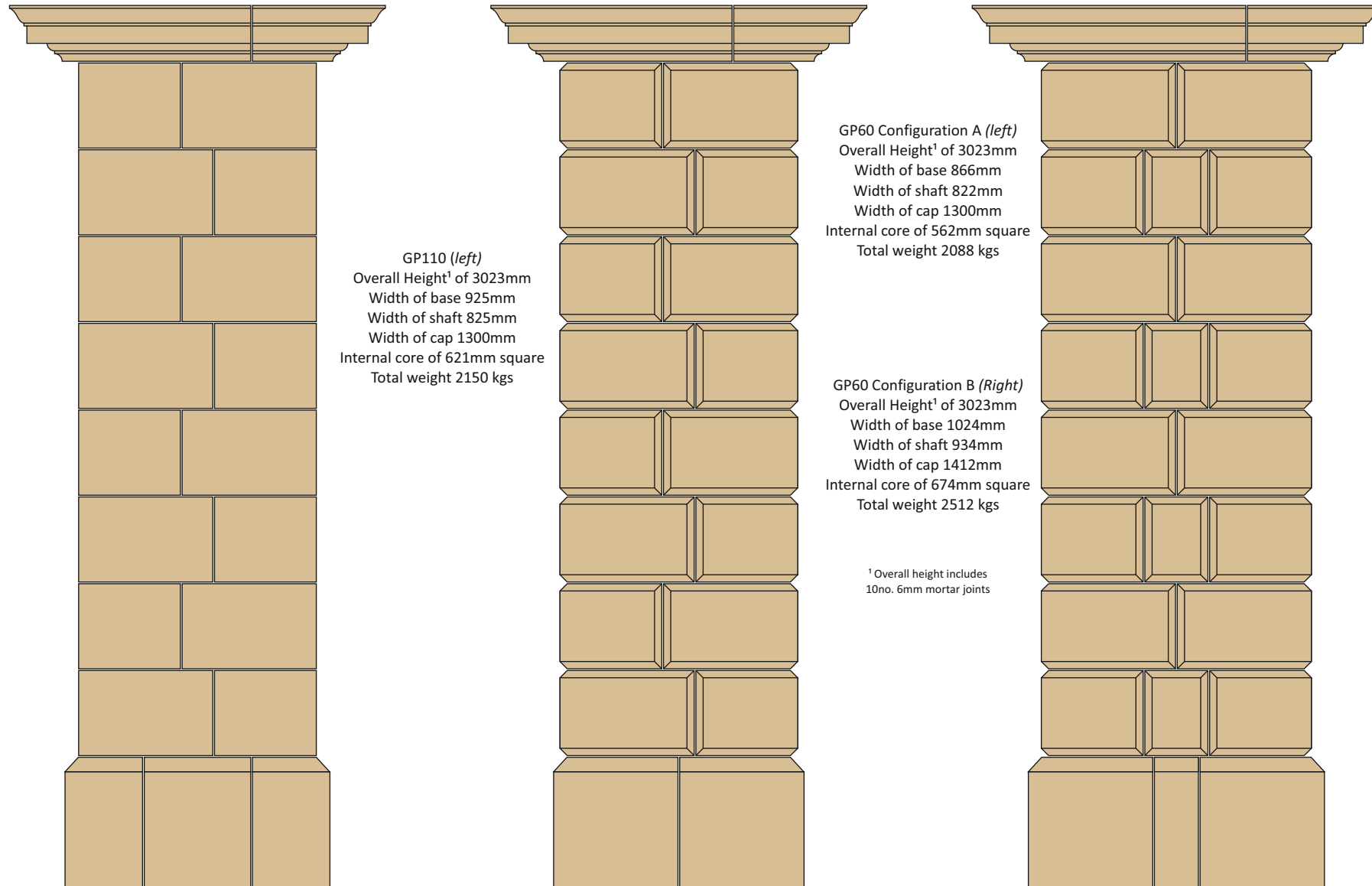

GP110 (left)
Overall Height¹ of 3023mm
Width of base 925mm
Width of shaft 825mm
Width of cap 1300mm
Internal core of 621mm square
Total weight 2150 kgs

GP60 Configuration A (left)
Overall Height¹ of 3023mm
Width of base 866mm
Width of shaft 822mm
Width of cap 1300mm
Internal core of 562mm square
Total weight 2088 kgs

GP60 Configuration B (Right)
Overall Height¹ of 3023mm
Width of base 1024mm
Width of shaft 934mm
Width of cap 1412mm
Internal core of 674mm square
Total weight 2512 kgs

¹ Overall height includes
10no. 6mm mortar joints

All our columns are available in a range of height configurations, please contact a member of our technical team with your requirements on 01258 472685.

Plain Coping

Our Plain Coping offers a simple and practical option where coping is required with limited detail.

Section

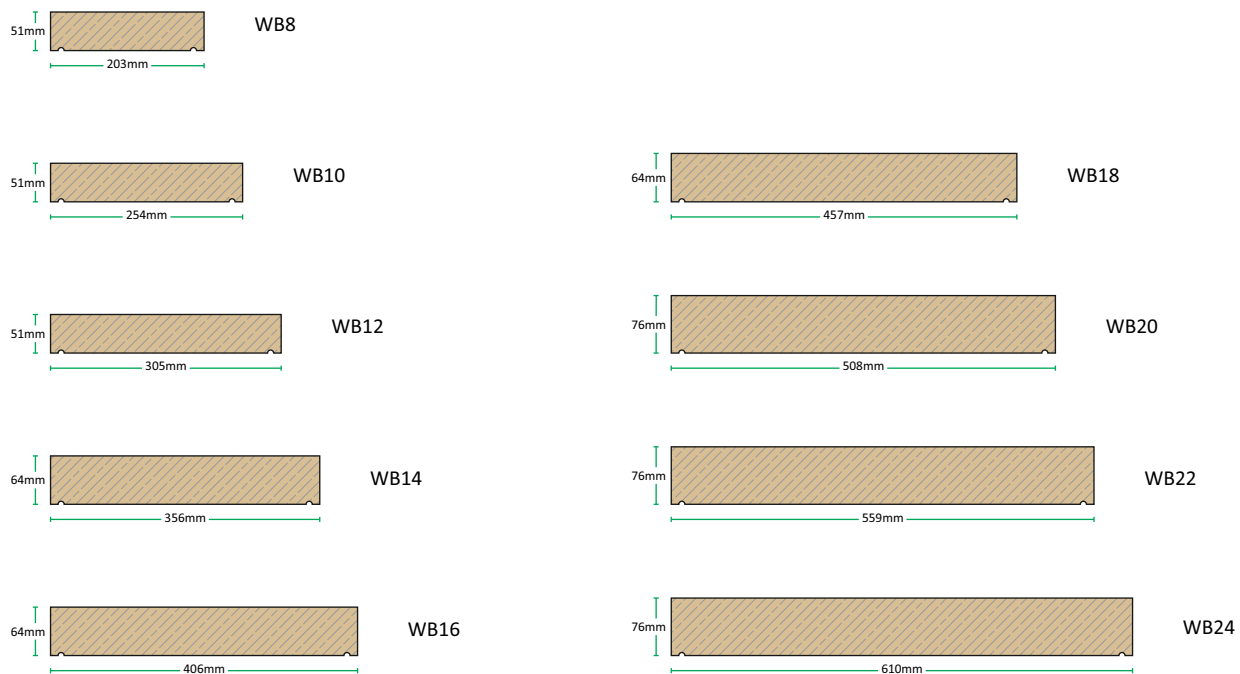

Typical installation detail

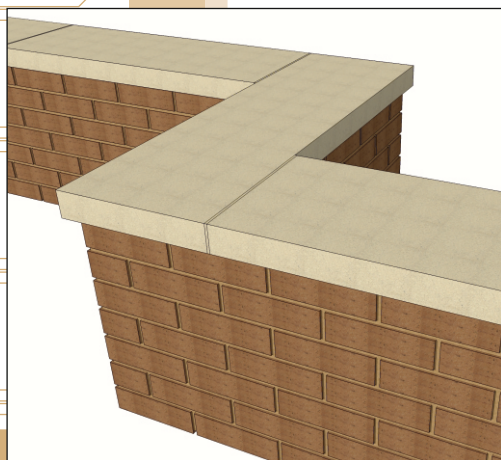

Due to its simple nature, our Plain Coping can be used in a number of configurations with ease. Please let us know if you require ends or returns as these can be made by simply modifying the placement of the drip channel.

If you require any further information, please call 01258 472685 and ask to speak to a member of our technical department.

Code	Max.*				
	Height (mm)	Width (mm)	Wall Width (mm)	Length (mm)	Weight (Kg)
WB8	51	203	153	1000	22
WB10	51	254	204	1000	27
WB12	51	305	255	1000	33
WB14	64	356	306	1000	48
WB16	64	406	356	1000	55
WB18	64	457	407	1000	61
WB20	76	508	458	1000	81
WB22	76	559	509	1000	89
WB24	76	610	560	1000	97

*Maximum wall width allows 25mm either side for drip and overhang.

Part Weathered Coping

Our Part Weathered Coping adds a subtle detail to the finish of any wall.

Straight	Max.*				
	Height	Width	Wall Width	Length	Weight
Code	(mm)	(mm)	(mm)	(mm)	(Kg)
WP8	51	203	153	1000	20
WP10	51	254	204	1000	25
WP12	51	305	255	1000	31
WP14	64	356	306	1000	46
WP16	64	406	356	1000	53
WP18	64	457	407	1000	59
WP20	76	508	458	1000	79
WP22	76	559	509	1000	87
WP24	76	610	560	1000	95

90° Returns	Dimension		Max.*		Dimension		Weight
	Height	A	Wall Width	B	(mm)	(Kg)	
Code	(mm)	(mm)	(mm)	(mm)	(mm)	(Kg)	
WP8C	51	203	153	203	4		
WP10C	51	254	204	254	6		
WP12C	51	305	255	305	9		
WP14C	64	356	306	356	16		
WP16C	64	406	356	406	22		
WP18C	64	457	407	457	27		
WP20C	76	508	458	508	40		
WP22C	76	559	509	559	47		
WP24C	76	610	560	610	58		

End Sections	Max.*				
	Height	Width	Wall Width	Length	Weight
Code	(mm)	(mm)	(mm)	(mm)	(Kg)
WP8E	51	203	153	1000	20
WP10E	51	254	204	1000	25
WP12E	51	305	255	1000	31
WP14E	64	356	306	1000	46
WP16E	64	406	356	1000	53
WP18E	64	457	407	1000	59
WP20E	76	508	458	1000	79
WP22E	76	559	509	1000	87
WP24E	76	610	560	1000	95

*Maximum wall width allows 25mm either side for drip and overhang.

Section

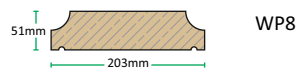

WP8

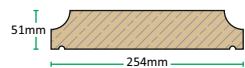

WP10

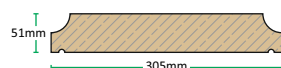

WP12



WP14



WP16



WP18



WP20



WP22



WP24

90° Return
(Shown in Plan)

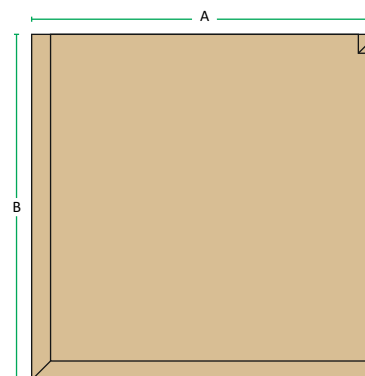

Our Part Weathered Coping is available in 1000mm straight lengths and end sections. 90 degree corners are also available.

If you require any further information, please call 01258 472685 and ask to speak to a member of our technical department.

Once Weathered Coping

Our Once Weathered Coping is perfect for parapets and walls where water needs to be shed in one direction.

Section

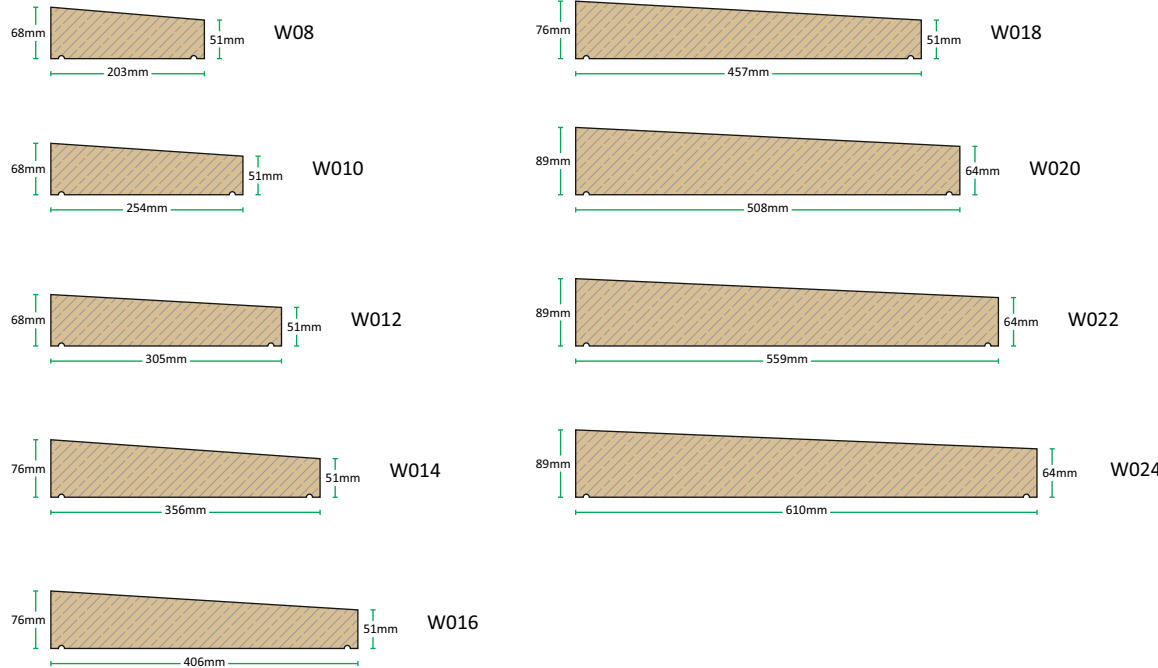

Due to the way in which our Once Weathered Coping sheds the water, we offer two types of returns.

A 'High Sided' return where the high side of the coping is on the outside of the corner, and a 'Low sided' return where the high side is on the inside of the corner.

Hopefully, the illustration shown should help you identify which type you require.

If you require any further information, please call 01258 472685 and ask to speak to a member of our technical department.

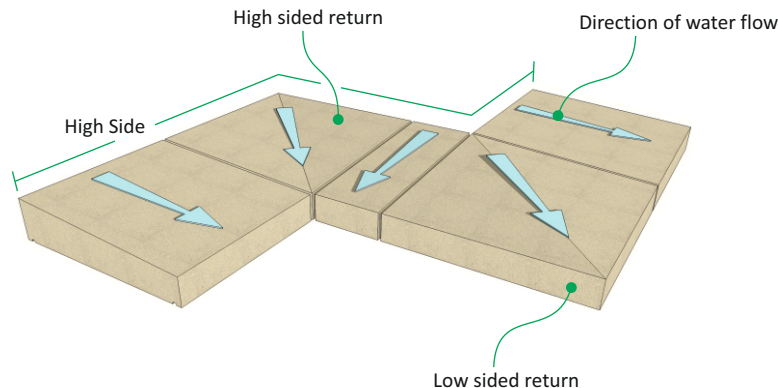

Straight	Max.*				
	Height (mm)	Width (mm)	Wall Width (mm)	Length (mm)	Weight (Kg)
W08	68	203	153	1000	25
W010	68	254	204	1000	31
W012	68	305	255	1000	37
W014	76	356	306	1000	47
W016	76	406	356	1000	54
W018	76	457	407	1000	61
W020	89	508	458	1000	82
W022	89	559	509	1000	90
W024	89	610	560	1000	98

High Sided Returns	Max.*				
	Height (mm)	Width (mm)	Wall Width (mm)	Length (mm)	Weight (Kg)
W08HS	68	203	153	203	6
W010HS	68	254	204	254	9
W012HS	68	305	255	305	12
W014HS	76	356	306	356	18
W016HS	76	406	356	406	23
W018HS	76	457	407	457	29
W020HS	89	508	458	508	43
W022HS	89	559	509	559	51
W024HS	89	610	560	610	61

Low Sided Returns	Max.*				
	Height (mm)	Width (mm)	Wall Width (mm)	Length (mm)	Weight (Kg)
W08LS	68	203	153	203	5
W010LS	68	254	204	254	8
W012LS	68	305	255	305	11
W014LS	76	356	306	356	18
W016LS	76	406	356	406	22
W018LS	76	457	407	457	28
W020LS	89	508	458	508	42
W022LS	89	559	509	559	50
W024LS	89	610	560	610	60

*Maximum wall width allows 25mm either side for drip and overhang.

Once Weathered Decorated Coping

Our Once Weathered Decorated Coping is perfect for parapets and walls where water needs to be shed in one direction.

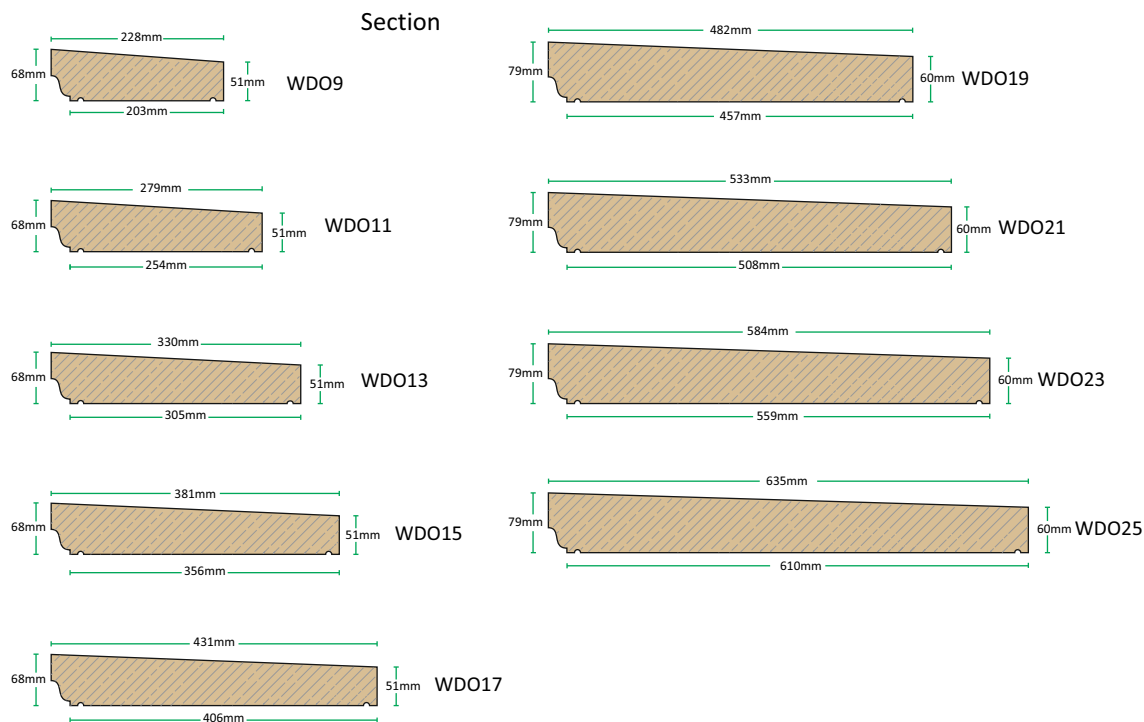

Code	Max.*				
	Height (mm)	Width (mm)	Wall Width (mm)	Length (mm)	Weight (Kg)
WDO09	68	228	153	1000	32
WDO11	68	279	204	1000	42
WDO13	68	330	255	1000	47
WDO15	68	381	306	1000	54
WDO17	68	431	356	1000	61
WDO19	79	482	407	1000	80
WDO21	79	533	458	1000	88
WDO23	79	584	509	1000	97
WDO25	79	635	560	1000	105

Code	Max.*				
	Height (mm)	Width (mm)	Wall Width (mm)	Length (mm)	Weight (Kg)
WDO09HS	68	228	153	228	7
WDO11HS	68	279	204	279	11
WDO13HS	68	330	255	330	15
WDO15HS	68	381	306	381	20
WDO17HS	68	431	356	431	26
WDO19HS	79	482	407	482	38
WDO21HS	79	533	458	533	47
WDO23HS	79	584	509	584	56
WDO25HS	79	635	560	635	69

Code	Max.*				
	Height (mm)	Width (mm)	Wall Width (mm)	Length (mm)	Weight (Kg)
WDO09LS	68	228	153	228	6
WDO11LS	68	279	204	279	9
WDO13LS	68	330	255	330	12
WDO15LS	68	381	306	381	16
WDO17LS	68	431	356	431	20
WDO19LS	79	482	407	482	29
WDO21LS	79	533	458	533	36
WDO23LS	79	584	509	584	43
WDO25LS	79	635	560	635	51

*Maximum wall width allows 25mm either side for drip and overhang.

Due to the way in which our Once Weathered Decorated Coping sheds the water, we offer two types of returns.

A 'High Sided' return where the high side of the coping is on the outside of the corner, and a 'Low sided' return where the high side is on the inside of the corner.

Hopefully, the illustration shown should help you identify which type you require.

If you require any further information, please call 01258 472685 and ask to speak to a member of our technical department.

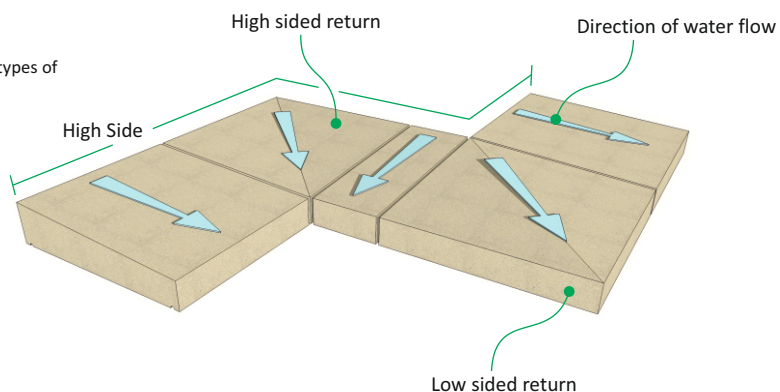

Twice Weathered Coping

Our Twice weathered Coping combines form and function to create simple protection for any wall

Straight	Max.*				
	Height	Width	Wall Width	Length	Weight
Code	(mm)	(mm)	(mm)	(mm)	(Kg)
WT8	64	203	153	1000	22
WT10	76	254	204	1000	31
WT12	76	305	255	1000	41
WT14	73	359	309	1000	47
WT16	76	406	356	1000	54
WT18	76	457	407	1000	61
WT20	76	508	458	1000	68
WT22	89	559	509	1000	90
WT24	102	610	560	1000	106

90° Returns	Dimension				Max.*	Dimension	Weight
	Height	A	Wall Width	B			
Code	(mm)	(mm)	(mm)	(mm)	(Kg)		
WT8C	64	203	153	203	4		
WT10C	76	254	204	254	8		
WT12C	76	305	255	305	13		
WT14C	73	359	309	359	17		
WT16C	76	406	356	406	22		
WT18C	76	457	407	457	28		
WT20C	76	508	458	508	35		
WT22C	89	559	509	559	50		
WT24C	102	610	560	610	65		

End Sections	Max.*				
	Height	Width	Wall Width	Length	Weight
Code	(mm)	(mm)	(mm)	(mm)	(Kg)
WT8E	64	203	153	1000	22
WT10E	76	254	204	1000	31
WT12E	76	305	255	1000	41
WT14E	73	359	309	1000	47
WT16E	76	406	356	1000	54
WT18E	76	457	407	1000	61
WT20E	76	508	458	1000	68
WT22E	89	559	509	1000	90
WT24E	102	610	560	1000	106

*Maximum wall width allows 25mm either side for drip and overhang.

Section

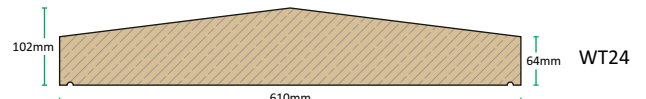
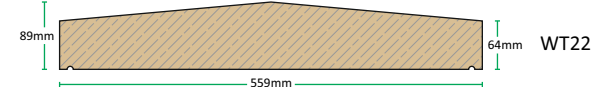
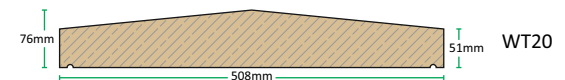
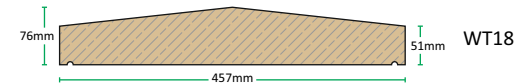
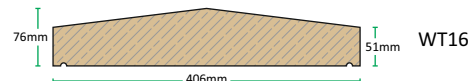
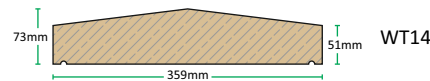
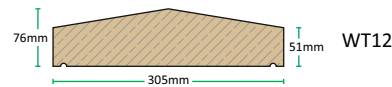
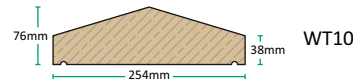
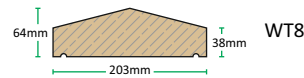

90° Return
(Shown in Plan)

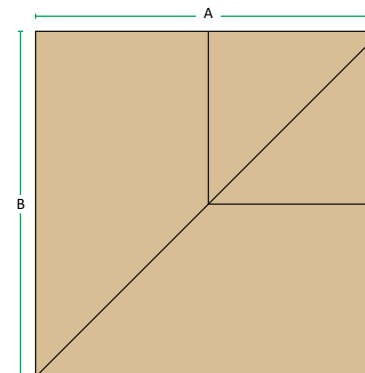

Our Twice Weathered Coping is available in 1000mm Straight lengths and end sections. 90 degree corners are also available.

If you require any further information, please call 01258 472685 and ask to speak to a member of our technical department.

Flat Decorated Coping

Our Flat Decorated Coping adds a classical detail making it particularly suitable for gables and more decorative walls.

Section

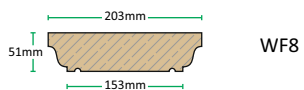

WF8

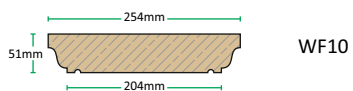

WF10

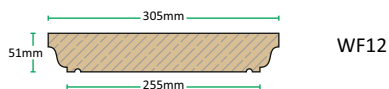

WF12

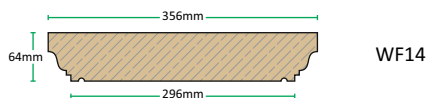

WF14

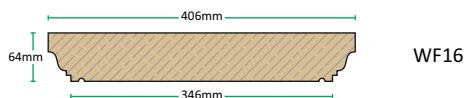

WF16

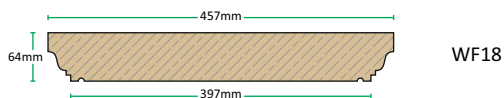

WF18

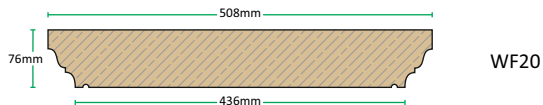

WF20

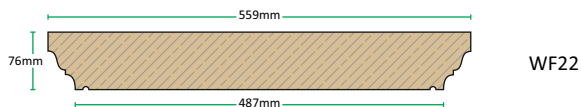

WF22

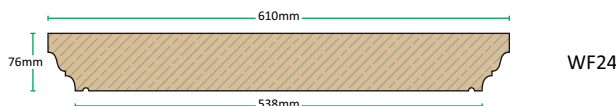

WF24

Straight Code	Max.*				
	Height (mm)	Width (mm)	Wall Width (mm)	Length (mm)	Weight (Kg)
WF8	51	203	103	1000	21
WF10	51	254	154	1000	26
WF12	51	305	205	1000	32
WF14	64	356	246	1000	46
WF16	64	406	296	1000	53
WF18	64	457	347	1000	59
WF20	76	508	386	1000	79
WF22	76	559	437	1000	87
WF24	76	610	488	1000	95

90° Returns Code	Dimension Height (mm)	Max.*		Dimension B (mm)	Weight (Kg)
		A (mm)	Wall Width (mm)		
WF8C	51	203	103	203	4
WF10C	51	254	154	254	7
WF12C	51	305	205	305	10
WF14C	64	356	246	356	17
WF16C	64	406	296	406	23
WF18C	64	457	347	457	28
WF20C	76	508	388	508	41
WF22C	76	559	437	559	48
WF24C	76	610	488	610	58

End Sections Code	Max.*				
	Height (mm)	Width (mm)	Wall Width (mm)	Length (mm)	Weight (Kg)
WF8E	51	203	103	1000	21
WF10E	51	254	154	1000	26
WF12E	51	305	205	1000	32
WF14E	64	356	246	1000	46
WF16E	64	406	296	1000	53
WF18E	64	457	347	1000	59
WF20E	76	508	386	1000	79
WF22E	76	559	437	1000	87
WF24E	76	610	488	1000	95

*Maximum wall width allows 25mm either side for drip and overhang.

Our Flat Decorated Coping is available in 1000mm straight lengths and end sections. 90 degree corners are also available.

If you require any further information, please call 01258 472685 and ask to speak to a member of our technical department.

90° Return
(Shown in Plan)

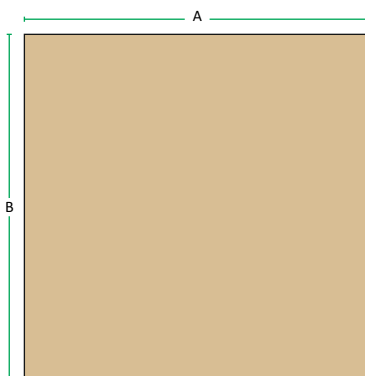

Weathered and Decorated Coping

Our Weathered and Decorated Coping adds both design and functionality to offer the highest level of classical detail.

Straight	Max.*					
	Height	Width	Wall	Width	Length	Weight
Code	(mm)	(mm)	(mm)	(mm)	(mm)	(Kg)
WD8	64	203	127	1000	19	
WD10	76	254	178	1000	30	
WD12	76	305	201	1000	40	
WD14	73	359	255	1000	43	
WD16	64	406	306	1000	52	
WD18	64	457	347	1000	58	
WD20	76	508	398	1000	65	
WD22	89	559	449	1000	87	
WD24	102	610	500	1000	104	

90° Returns	Dimension		Max.*		Dimension	Weight
	Height	A	Wall	Width		
Code	(mm)	(mm)	(mm)	(mm)	(mm)	(Kg)
WD8C	64	203	127	203	4	
WD10C	76	254	178	254	8	
WD12C	76	305	201	305	13	
WD14C	73	359	255	359	15	
WD16C	64	406	306	406	21	
WD18C	64	457	347	457	26	
WD20C	76	508	398	508	33	
WD22C	89	559	449	559	48	
WD24C	102	610	500	610	64	

End Sections	Max.*					
	Height	Width	Wall	Width	Length	Weight
Code	(mm)	(mm)	(mm)	(mm)	(mm)	(Kg)
WD8E	64	203	127	1000	19	
WD10E	76	254	178	1000	30	
WD12E	76	305	201	1000	40	
WD14E	73	359	255	1000	43	
WD16E	64	406	306	1000	52	
WD18E	64	457	347	1000	58	
WD20E	76	508	398	1000	65	
WD22E	89	559	449	1000	87	
WD24E	102	610	500	1000	104	

Section

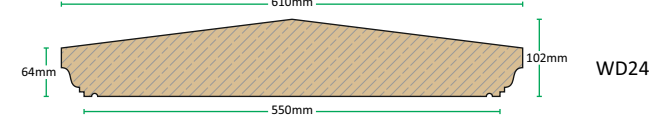
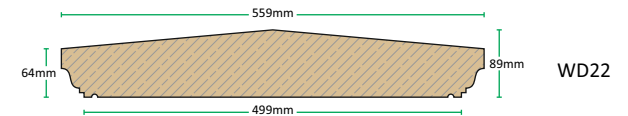
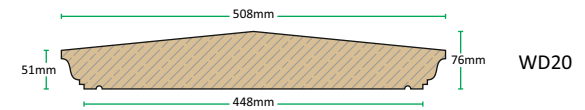
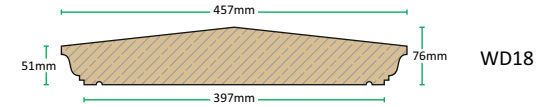
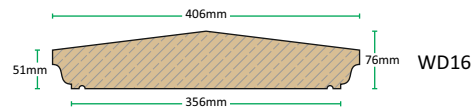
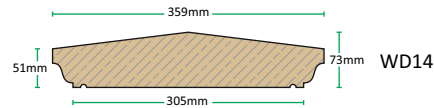
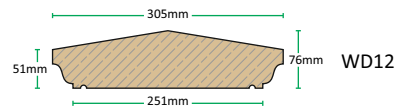
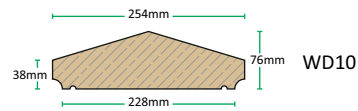
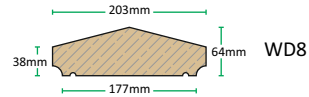

Our Weathered and Decorated Coping is available in 1000mm straight lengths and end sections. 90 degree corners are also available.

If you require any further information, please call 01258 472685 and ask to speak to a member of our technical department.

90° Return
(Shown in Plan)

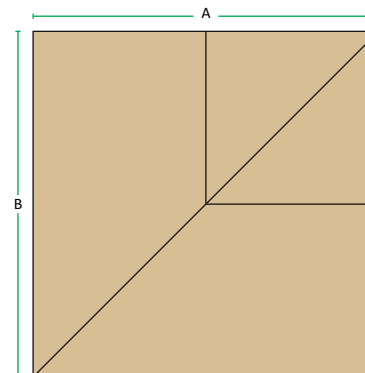

CAD Files

Drawings of all our Walls, Piers and Finial features are available for downloading by visiting our website.

	AutoCAD®	Sketchup®	Acrobat®		AutoCAD®	Sketchup®	Acrobat®
Balls and Bases				Gate Piers			
9" Balls and Bases	✓	✓	✓	GP120, GP10, and GP20 Gate Piers	✓	✓	✓
12" Balls and Bases	✓	✓	✓	GP70A Gate Pier	✓	✓	✓
14" Balls and Bases	✓	✓	✓	GP90 Gate Pier	✓	✓	✓
17" Balls and Bases	✓	✓	✓	GP60 and GP110 Gate Piers	✓	✓	✓
Pier Caps				Coping			
Plain and Part Weathered	✓	✓	✓	Plain Coping	✓	✓	✓
Flat Decorated	✓	✓	✓	Part Weathered	✓	✓	✓
Weathered Plain	✓	✓	✓	Once Weathered	✓	✓	✓
Weathered Decorated	✓	✓	✓	Twice Weathered	✓	✓	✓
Combination Ideas 440mm Pier	✓	✓	✓	Flat Decorated	✓	✓	✓
Combination Ideas 552mm Pier	✓	✓	✓	Weathered Decorated	✓	✓	✓
Combination Ideas 665mm Pier	✓	✓	✓				

File Viewers

If you do not have the software to view these files, free viewing software is available by visiting the relevant website below

AutoCAD®

Autodesk® DWG TrueView™ software is a free stand-alone DWG™ viewer. Visit their website to download <http://usa.autodesk.com/>

Sketchup®

Anyone can use the free SketchUp Viewer to view and print models created in SketchUp. Visit their website to download <http://sketchup.google.com/>

Acrobat Reader®

Use Adobe Reader to view, search, verify, print, and collaborate on Adobe PDF files. Visit their website to download <http://www.adobe.com>

Glossary and FAQ's

To help you and answer a few of your questions, we have compiled this handy list of commonly used terms and questions.

Glossary

Drip - A drip is an indent on the underside of a cill or a coping stone, this causes the water to gather and drip at that point, keeping the falling water away from the wall. The drip is also referred to as 'throated'.

Weathering - This refers to the slope on the top side of copings and pier caps. This slope is what would shed the water that would otherwise collect on the top surface.

Weathered Pier Caps are similar in design to the copings but with the weathering tapering to all four sides.

Once Weathered - This style of weathering is designed to shed water in one direction.

Twice Weathered - Twice weathered copings shed water in two directions to either side of the wall.

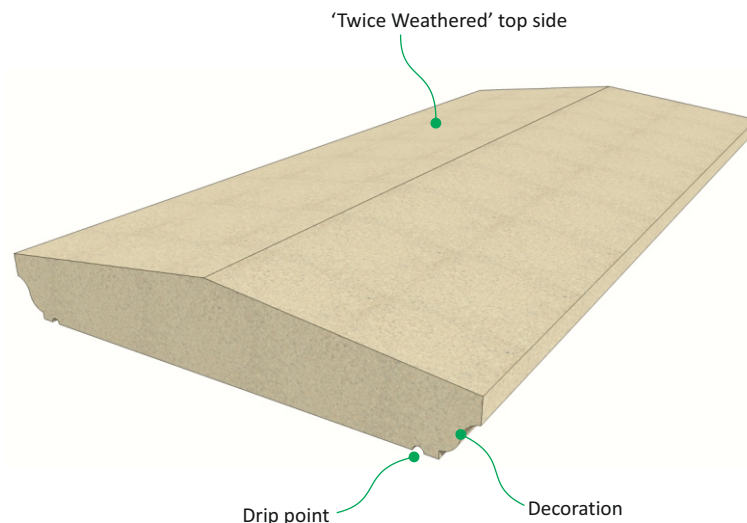

FAQ

Can you cut the Stone?

Our stone cuts and carves just as true sandstone. A consistent texture throughout ensures that our product cuts and carves smoothly.

Is your coping available to suit a curved wall?

Our standard copings are supplied in 1000mm straight sections, if you require curved in either plan or elevation, please contact a member of our technical team on 01258 472685.

Can the coping be used to seal a cavity wall?

Copings used on parapet walls and gables should be used in conjunction with a suitable DPC.

Is the stone frostproof?

All our stone products are frost proof and are unaffected in normal conditions if installed correctly.

How does the stone age?

The stone ages in a similar way to true stone, this can be encouraged or slowed by using a number of readily available products after installation.

How do we fix the stone?

There are a range of fixings specially designed for cast stone. If required we can cast in fixings subject to your specification.

Are there installation guides?

Each of our products has a guide available. These are available from our technical department.

What colours are available?

All our standard products are available in our six standard colours Portland White, Cotswold, Bath Yellow, Yorkstone, Devon Red, and Shaftesbury Green.

Bespoke and colour matching is available as a special order.

Do I need an account to order with you?

We supply both the trade and private customers alike, you do not need an account with us to place an order. We do however request a deposit at the time of order.

Is pointing mix supplied?

Where required, we supply sufficient colour matched aggregate free of charge. We recommend that this is mixed at a ratio of 4:1 with Portland White Cement. Full pointing instructions are available upon request.

Address Cranborne Stone Ltd
Butts Pond
Sturminster Newton
Dorset
DT10 1AZ

Fax 01258 471251

Telephone 01258 472685

email info@cranbornestone.com

web www.cranbornestone.com